



Installation Guide & User Manual

PERSONAL PA[®] Value Pack System

Wide-Band FM Wireless Listening System

Model PPA VPE

Transmitter Model T17, T17-6
Receiver Model R7, R7-4, R7-6

 **Williams Sound[®]**
Helping People Hear



PERSONAL PA® VALUE PACK SYSTEM, MODEL PPA VPE

INSTALLATION GUIDE & USER MANUAL

CONTENTS	PAGE
SYSTEM OVERVIEW	4
SYSTEM CONTROLS AND FEATURES	5
SYSTEM SET-UP AND OPERATION	7
ANTENNA CONNECTION	
POWER CONNECTION	
AUDIO CONNECTION	
USING A MICROPHONE	
TURNING OFF DC MICROPHONE POWER	
RECEIVER USE INSTRUCTIONS	9
PPA R7 RECEIVER	
ADDITIONAL RECEIVERS	
USING A RECEIVER WITH A HEARING AID	
BATTERY INFORMATION	11
SINGLE-USE BATTERIES	
RECHARGEABLE BATTERIES	
TROUBLESHOOTING GUIDE	12
FREQUENCY CHANGE INSTRUCTIONS	14
TRANSMITTER FREQUENCY CHANGE INSTRUCTIONS	
RECEIVER FREQUENCY CHANGE INSTRUCTIONS	
RECEIVER MANAGEMENT SUGGESTIONS	17
WARRANTY	18
SYSTEM SPECIFICATIONS	19

SYSTEM OVERVIEW

Thank you for purchasing the Personal PA Value Pack System from Williams Sound Corporation. The PPA VPE System is a Wide-Band FM Listening System which operates in the 72-76 MHz frequency band. Designed for hearing assistance in places of public access, the PPA VPE is for those who need help overcoming background noise, reverberation, or distance from the sound source. The versatile PPA VPE is easily integrated with your existing sound system or can be used with a microphone as a stand-alone system.

The system has two principal parts: the T17 Transmitter and the R7 Receivers. Much like a miniature radio station, the Transmitter and microphone pick up the sounds you want to hear and broadcast them over an FM radio signal. The receivers are used to pick up the broadcast up to 500 feet away.

To avoid difficulties, please read through these instructions as you begin to use the system. Then save the manual for questions that arise as you continue to use your PERSONAL PA Value Pack System.

If you have any problems with this Williams Sound product, don't hesitate to call us toll-free at 1-800-843-3544.

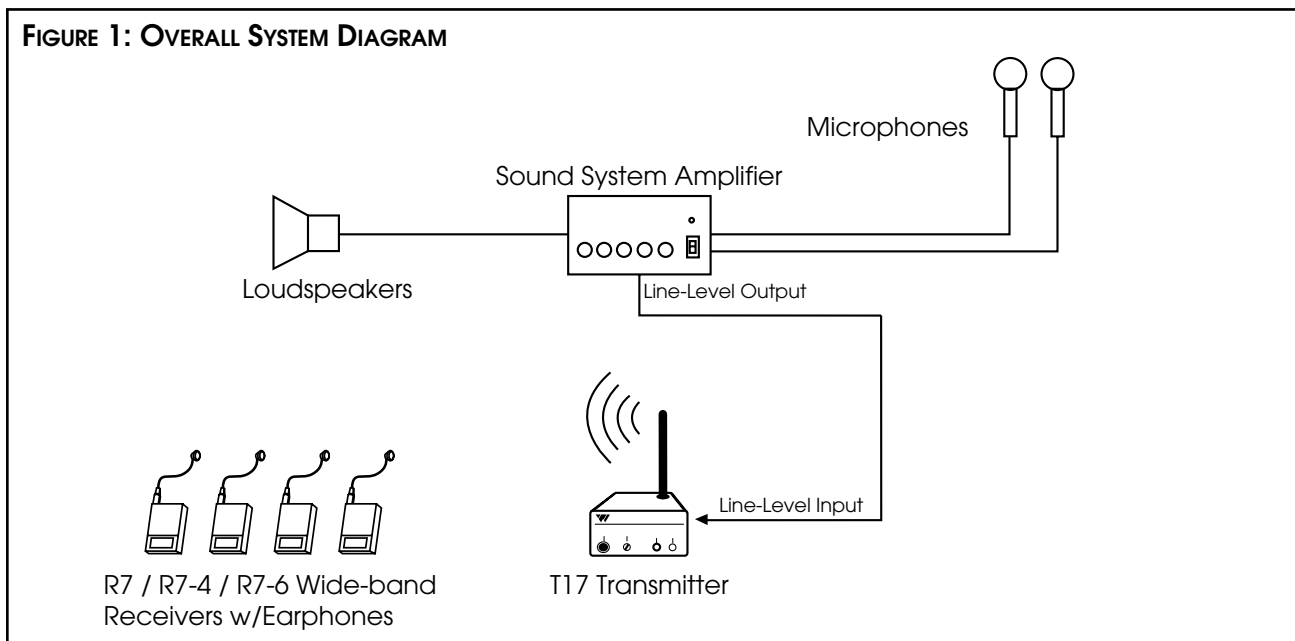

FIGURE 2: T17 TRANSMITTER CONTROLS

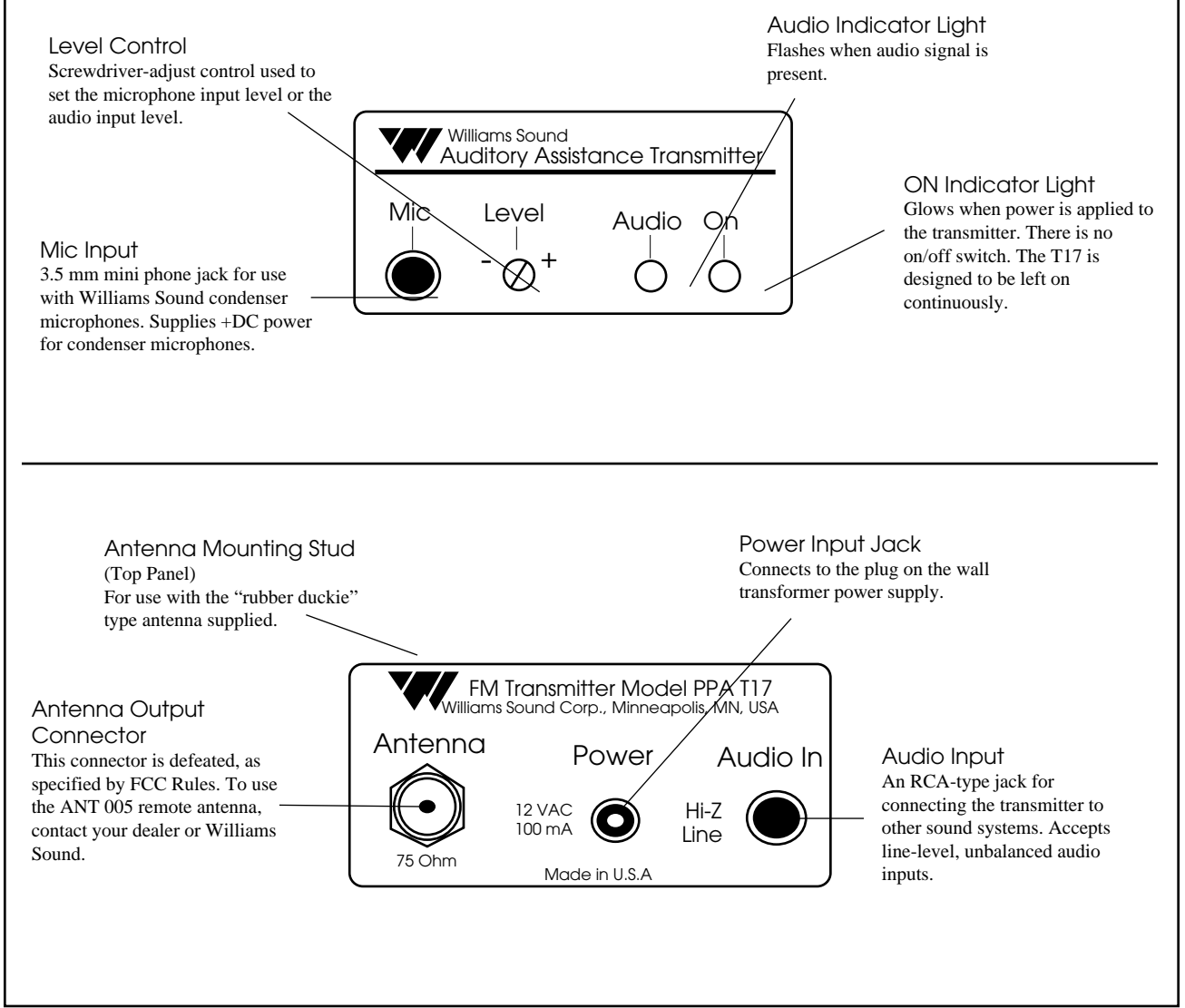
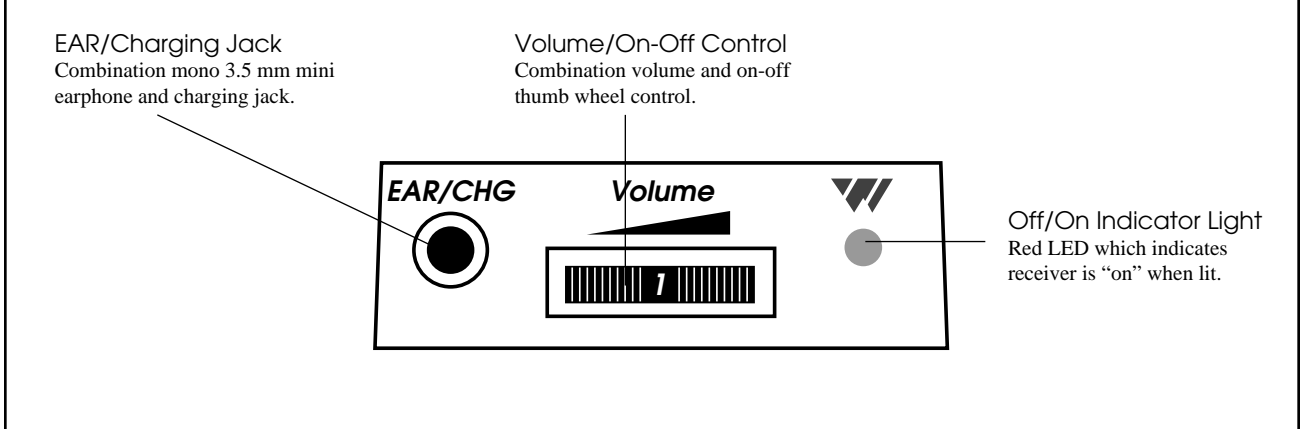

FIGURE 3: R7 RECEIVER CONTROLS





SYSTEM CONTROLS AND FEATURES

T17 TRANSMITTER FRONT PANEL

MIC INPUT:

3.5 mm mini phone for use with Williams Sound condenser microphones. Supplies +DC power for condenser microphones.

LEVEL CONTROL

Screwdriver-adjust control used to set the microphone input level or the audio input level.

ON INDICATOR LIGHT

Glows when power is applied to the transmitter. There is no on/off switch. The T17 is designed to be left on continuously.

AUDIO INDICATOR LIGHT

Flashes when audio signal is present.

T17 TRANSMITTER TOP PANEL

ANTENNA MOUNTING STUD

For use with the “rubber duckie” type antenna supplied with the T17.

T17 TRANSMITTER REAR PANEL

POWER INPUT JACK

Connects to the plug on the wall transformer power supply.

AUDIO INPUT

An RCA-type jack for connecting the transmitter to other sound systems. Accepts line-level, unbalanced audio inputs.

ANTENNA OUTPUT CONNECTOR

This connector is defeated, as specified by FCC Rules. To use a remote antenna, contact your dealer or Williams Sound.

RECEIVER MODEL R7

EAR JACK

3.5 mm mini earphone jack

OFF/ON INDICATOR LIGHT

Red LED which indicates receiver is “on” when lit. If the batteries are near end of life and the LED turns off while the receiver is operating, approximately one hour of battery life remains.

VOLUME/ON-OFF CONTROL

Combination volume and on-off rotary control.

SYSTEM SET-UP AND INSTALLATION

STEP 1: INSTALL THE ANTENNA

The “rubber duckie” whip antenna fits into the hole on top of the transmitter and threads onto a mounting stud inside. Guide the antenna onto the stud and turn it clockwise to tighten. Do not use excessive force to tighten the antenna. It only needs to be “finger-tight.”

STEP 2: CONNECT THE TRANSMITTER TO POWER

The T17 is supplied with a wall transformer power supply. Plug the transformer into a 120 V, 60 Hz wall outlet. Then plug the power cord into the “Power” connector on the rear panel of the T17. The green indicator light on the front panel of the T17 should glow when the power is connected.

There is no on/off switch. The T17 is designed to be continuously on. The wall transformer can be plugged into a switched outlet that turns on when the other sound equipment is turned on. If turning the T17 on creates a hum or buzz in the sound system, see the Troubleshooting section on page 12.

STEP 3: MAKE AUDIO CONNECTIONS

3A: (IF YOU WILL BE USING THE T17 WITH ITS OWN MICROPHONE AS A STAND-ALONE SYSTEM)

Any Williams Sound microphone with a 3.5 mm mini phone plug can be used with the T17. Plug the microphone into the “Mic” jack on the front panel of the T17.

The T17 is designed to supply positive DC voltage to the plug tip of 2-wire, “barefoot” electret (power condenser) microphones. If you will be using the T17 with a non-Williams Sound, Lo-Z (dynamic) microphone, this DC power should be turned off. (See page 8.) If you use both the Microphone input and the Audio Input on the T17, the signals will be mixed together.

3B: (IF YOU WILL BE USING THE T17 WITH AN EXISTING SOUND SYSTEM)

Refer to the figure 1 on page 4. Use the audio cable supplied to connect the T17 “Audio In” jack to an appropriate audio output jack on the sound system mixer or amplifier. The T17 is designed to work with an unbalanced, line-level audio signal. Suitable connections are:

- Choice 1: TAPE OUT or LINE OUT Jack
- Choice 2: BOOSTER or BRIDGING Jack
- Choice 3: Speaker Terminal, 8 Ohm Tap

If your amplifier or mixer does not have RCA-type connectors, you can obtain adapters from your Williams Sound Authorized Dealer or a local radio parts store. If the TAPE OUT jack is already in use, a Y-Cord can be used to connect the T17 and a second device to the same jack.

STEP 4: TEST THE SYSTEM

Use a receiver to test the system and set the input level control. See the section, *Receiver Use Instructions*.

TURNING OFF DC MICROPHONE POWER

The T17 is designed to supply positive DC voltage to the plug tip of 2-wire, “barefoot” electret (power condenser) microphones. If you will be using the T17 with a non-Williams Sound, Lo-Z (dynamic) microphone, this DC power should be turned off. (See Figure 4.) If you use both the Microphone input and the Audio Input on the T17, the signals will be mixed together.

Step 1: Unplug the power cord from the T17 and remove its antenna.

Step 2: Use a phillips-type screwdriver to loosen the two screws on the rear of the Transmitter. Remove the cover. Slide the circuit board out of the case.

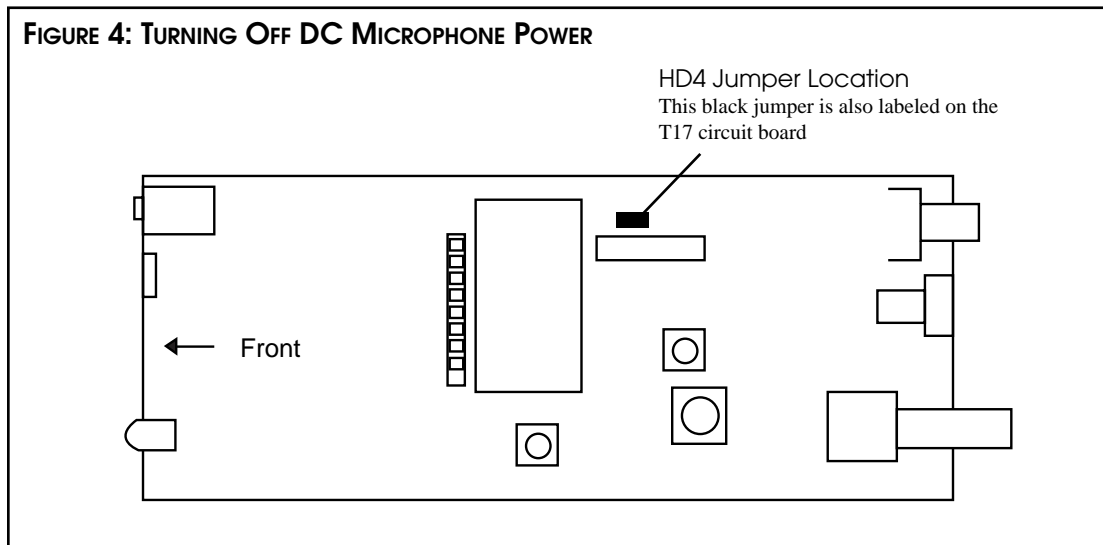

Step 3: Use the diagram to locate the HD4 Jumper. This black jumper is also labeled on the T17 circuit board.

Step 4: Pull the HD4 Jumper off the two pins it connects. **DO NOT MAKE ANY OTHER ADJUSTMENTS!** For handy storage, simply turn the jumper sideways and place it on just one of the two pins.

Step 5: Re-assemble the Transmitter.

RECEIVER USE INSTRUCTIONS

RECEIVER MODEL PPA R7

Receiver Model PPA R7 has a single, wheel-type volume control and an earphone output jack.

BATTERY INSTALLATION

Open the battery compartment using a coin in the slot in the bottom of the receiver. Press the battery into place, **observing proper battery** polarity. Incorrect insertion of the battery is difficult, and may cause both mechanical and electrical damage to the receiver not covered by the 5 year warranty. The receiver will not work with the battery incorrectly installed.

CONNECTING EARPHONES

Plug an earphone into the jack near the thumb wheel volume control. Only monophonic earphones will operate properly. If stereo headphones are used, sound will be heard only in one side. A suitable adapter (Radio Shack Part #274-368), can be used so that stereo earphones operate on both sides. Williams Sound extensively evaluates the earphones and headphones included with the PPA 250. We can only assure optimum performance when Williams sound earphones and headphones are used.

OPERATING THE RECEIVER

Turn the receiver on by rotating the volume control in the direction of the arrow on top of the case. The “On” indicator will light.

Turning the knob in the direction of the arrow will increase the volume. Turning the knob against the arrow will decrease the volume. To avoid depleting the battery, make sure the receiver is turned off when not in use.

If you're using the PPA VPE with an existing sound system, make sure the sound system is turned on. Have someone speak into a sound system microphone while you listen with the receiver and earphone. You should be able to hear their voice through the receiver.

If you're using the PPA VPE with a microphone—and not a complete sound system—have someone speak into the microphone while you listen with the receiver and earphone. You should be able to hear their voice through the receiver.

Note: The earphone cord is the receiving antenna. Do not bunch up the cord or wrap it around the receiver.

ADDITIONAL RECEIVER INSTRUCTIONS

MODELS PPA R7-4 AND PPA R7-6

The R7-4 and R7-6 receivers feature a channel selector knob on top of the receiver. Turn the selector knob until you hear the desired program.

MODEL PFM R16

The R16 Receiver features an environmental microphone input and dual volume controls. The taller knob turns the receiver on and off and controls the transmitted signal level. The shorter knob controls the microphone signal level. By adjusting the two volume controls, you can hear a mixture of the transmitted signal and nearby sounds.



Note: Some users may not be helped by this system. Severe hearing loss may require using the system with a telecoil coupler (i.e., Neckloop) and personal hearing aid.

USING A RECEIVER WITH A HEARING AID

Williams Sound PPA Receivers can be used with hearing aids using three different methods:

NECKLOOP TELECOIL COUPLER

Neckloops are cords which hang around the neck and couple magnetically with T-Coil equipped hearing aids.

SILHOUETTE TELECOIL COUPLER

These telecoil couplers are worn behind the ear, right next to telecoil-equipped hearing aids.

DIRECT AUDIO INPUT (DAI) CORD

Direct Audio Input cords can be used with compatible hearing aids as well as with Cochlear Implant Processors.

BATTERY INFORMATION

SINGLE USE BATTERIES

In normal use, a heavy-duty 9 Volt battery such as the Eveready 216 will last about 10 hours. Alkaline batteries such as the Eveready 522 will provide about 32 hours of use. If the sound becomes weak or distorted, replace the battery. The indicator light may still be on, even with a battery that is weak. Do not leave dead batteries in the receivers. Battery corrosion is not covered by the Williams Sound five year warranty.

!! WARNING !!

DO NOT ATTEMPT TO RECHARGE SINGLE USE BATTERIES!

The batteries may heat up and burst, causing possible injury and damage to the equipment.

Avoid shorting the plus and minus battery terminals together with metal objects. Battery damage and burns can result!

Use only Williams Sound supplied chargers and batteries!

RECOMMENDED BATTERIES

For Receiver:

Eveready 216 Carbon 9V, Eveready 522 Alkaline 9V or equiv.

BAT 003 rechargeable NiMH only

BAT 004, BAT 005, or CHG 1269 Chargers only for BAT 003

BATTERY LIFE

For Receiver:

15 hours for Eveready 216 Carbon 9V or equivalent

32 hours for Eveready 522 Alkaline 9V or equivalent

6 hours per charge for BAT 003 rechargeable

If the sound becomes weak or distorted, replace the battery. The indicator light may still be on, even with a battery that is weak. Do not leave dead batteries in the receivers.

FURTHER SUGGESTIONS

Receivers SHOULD NOT be left charging continuously when not in use. Receivers should always be turned OFF while charging.

It's best to allow the batteries to fully discharge before charging. If the batteries are near end of life and the LED turns off while the receiver is operating, approximately one hour of battery life remains. Repeatedly charging the batteries after short periods of use (1-2 hours) will shorten battery life. Rechargeable batteries will need to be replaced after 1-2 years of use.

TROUBLE SHOOTING GUIDE

TRANSMITTER “POWER” LIGHT NOT ON.

- ▶ Make sure the wall transformer is plugged into the transmitter.
- ▶ Make sure the electrical outlet is on.

NO SOUND THROUGH RECEIVERS.

- ▶ If some of the receivers work, but others don't, check for bad batteries or earphones on the receivers that aren't working.
- ▶ Check to see that the receiver frequency matches the transmitter frequency. The frequency sticker is on the bottom of the transmitter and inside the back cover of the receiver. If they do not match, see *Frequency Change Instructions* on page 14.
- ▶ If none of the receivers work, check to see if the power is connected to the transmitter and the “Power” light is on.
- ▶ Check to see if the Transmitter is connected properly to the sound system. See page 7.
- ▶ Turn the screwdriver-adjust input level control located on the T17 front panel clockwise to increase the input signal strength. Check to see that the audio light is flashing occasionally but not continuously.
- ▶ If you are not using an input signal from a sound system, make sure the Williams Sound microphone is plugged into the “Mic” jack on the front of the T17 transmitter.
- ▶ Make sure the antenna is installed and connected properly. See page 7.

INSUFFICIENT RANGE, GOOD RECEPTION NEAR TRANSMITTER, POOR AT A DISTANCE

- ▶ Check to see if the antenna was installed correctly. If not, correct or replace the antenna. The signal should be clearly audible at a 300 foot distance.

SOUND THROUGH RECEIVERS IS LOUD, BUT DISTORTED. NOISE (ROOM NOISE OR ELECTRONIC NOISE) SEEMS TO GROW AFTER TALKING STOPS. AUDIO INDICATOR LIGHT IS CONTINUOUSLY ON.

- ▶ Turn the screwdriver-adjust input level control located on the T17 front panel counter-clockwise to decrease the input signal strength. The audio indicator light should flash, not be lit continuously.

SOUND THROUGH THE RECEIVERS IS WEAK AND NOISY. AUDIO INDICATOR LIGHT IS NOT LIT.

- ▶ Turn the screwdriver-adjust input level control located on the T17 front panel clockwise to increase the input signal strength. The audio indicator light should be flashing
- ▶ Increase the input signal level from the sound system.

SCRATCHY NOISE WHEN RECEIVER VOLUME CONTROL IS ADJUSTED.

- ▶ Follow the steps below:
 1. Open the back of the receiver case by opening the battery compartment. Keep lifting on the battery door and the back of the receiver case will open like a book.

- 
2. Remove the screw from the center of the volume control and remove the knob.
 3. Lift the clear plastic cover on the control and spray GC SPRA-KLEEN, LPS Contact Cleaner, or equivalent into the control. Replace the knob and rotate the control several times.
 4. Replace the screw and close the case.

BUZZING OR HUMMING NOISE IN SOUND SYSTEM.

- ▶ There is nothing wrong with the T17 Transmitter. One or more pieces of equipment in the sound system are being disturbed by RF (Radio Frequency) signals produced by the T17. The most likely suspects are your amplifier, mixer, or tape deck. The RF gets into the other equipment primarily through the power cord, speaker wires, or unshielded inputs, all of which can act as antennas. Try the following steps.
 1. Move the Transmitter away from the other sound equipment.
 2. Make sensitive equipment more immune to RFI/EMI. The manufacturers of your audio equipment may offer application notes for this purpose. Williams Sound offers a document giving suggestions for improving RF immunity in existing audio equipment. (*Technical Bulletin: Buzz Or Hum In The Sound System, FRM 531*) Unless you have the necessary technical skills, this is best left to a qualified electronics repair technician.

FREQUENCY CHANGE INSTRUCTIONS

Normally, the PPA VPE's factory-set channel (usually 72.9 MHz) requires no change. However, if another hearing assistance system or authorized radio service is operating on 72.9 MHz in your area, it may prove necessary to use an alternate channel. In this event, the PPA VPE's operating frequency can easily be changed to an alternate channel to avoid interference.

TRANSMITTER FREQUENCY CHANGE INSTRUCTIONS:

IMPORTANT: Some cities have other radio services licensed on hearing assistance channels. Under FCC rules governing hearing assistance, you must yield to them. A list of cities where other radio services are known to exist is included with the transmitter. Do not use frequencies that are known to be used by licensed radio services in your city, either if they are on the list or if you discover one.

- Step 1:** Unplug the power cord from the Transmitter and remove the antenna.
- Step 2:** Use a phillips-type screwdriver to loosen the two screws on the rear of the Transmitter. Remove the cover. Slide the circuit board out of the case.
- Step 3:** Use the diagram to locate the frequency selector switches on the circuit board. Locate the switch programming chart on the bottom of the Transmitter case.

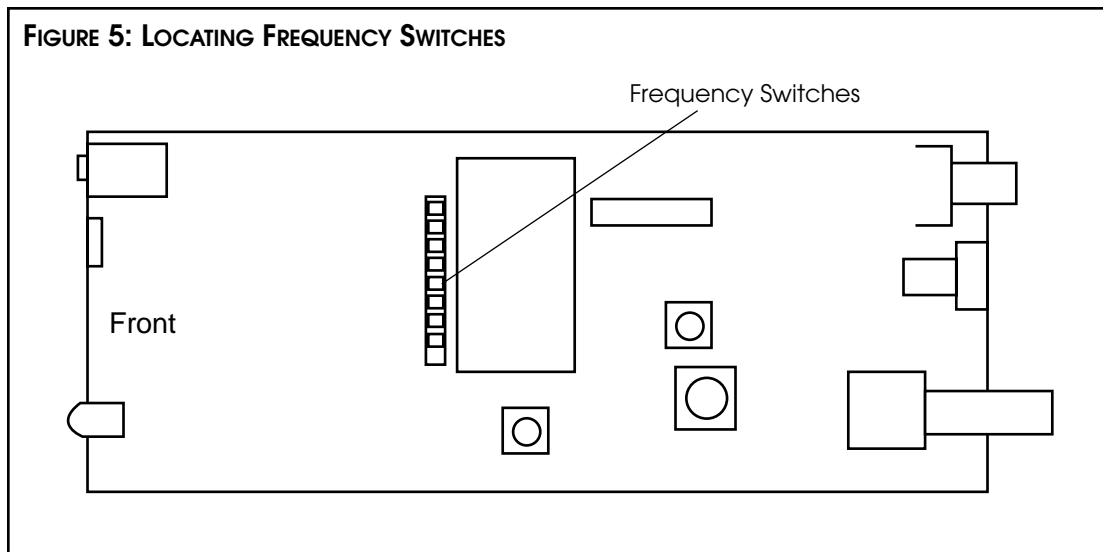

Step 4: Use a paper clip or small screwdriver (not a pencil point) to move the switches to correspond with the switch positions on the programming chart. (See Figure 6.) Select a new frequency at least two channels away from the one you are experiencing interference on. **DO NOT TOUCH ANY OF THE OTHER ADJUSTMENTS!**

FIGURE 6: SETTING THE T17 FREQUENCY SELECTOR SWITCHES



FREQUENCY (MHz)	SWITCH SETTINGS							
	1	2	3	4	5	6	7	8
72.1	DN	UP	DN	UP	DN	DN	DN	DN
72.3	DN	UP	DN	UP	UP	DN	DN	DN
72.5	DN	UP	DN	UP	DN	DN	UP	DN
72.7	DN	UP	DN	UP	UP	DN	UP	DN
72.9	DN	UP	DN	UP	DN	DN	DN	UP
75.5	UP	UP	DN	UP	UP	DN	DN	DN
75.7	UP	UP	DN	UP	DN	DN	UP	DN
75.9	UP	UP	DN	UP	UP	DN	UP	DN
74.7	UP	DN	DN	UP	UP	DN	DN	UP
75.3	UP	UP	DN	UP	DN	DN	DN	DN

Step 5: Re-assemble the Transmitter and plug it in. Connect a tape player or radio to the transmitter to provide a tuning signal for the receivers.

RECEIVER FREQUENCY CHANGE INSTRUCTIONS

Tuning for the R7, R30, R31, and R32 receivers is determined by a single tuning coil. In the R7-4 and R7-6, one coil is assigned to each switch position. See the following 6 figures and receiver types to locate the coils to be adjusted. A plastic tuning wrench (PLT 005) will be needed to adjust these receiver tuning coils.

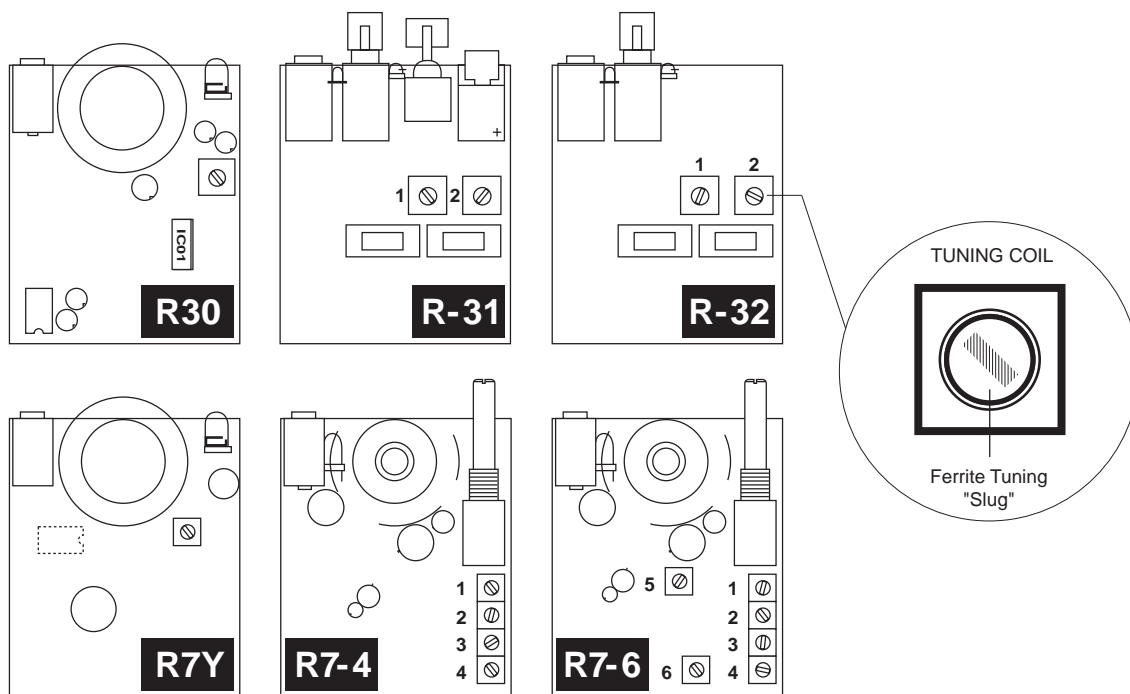

Most Williams Sound single channel Receivers are set at the factory to 72.9 MHz. The standard four-channel receivers (R7-4NA), Channels 1-4, are usually set to frequencies 72.1, 72.5, 72.9, 75.7 MHz respectively. The standard six-channel receivers (R7-6N), channels 1-6, are set to frequencies 72.1, 72.5, 72.9, 75.7, 74.7 and 75.3 MHz respectively.

The Receiver must be tuned with a weak and somewhat noisy signal. If tuned too close to the transmitter, with a strong signal, the most accurate tuning of the receiver is not possible.

To Change the Frequency to Another Channel:

- Step 1:** Set the transmitter to the channel desired and remove the antenna.
- Step 2:** Connect an audio source to the transmitter such as a CD or cassette player or microphone.
- Step 3:** Move the receiver about 25 feet away from the transmitter to set the tuning.
- Step 4:** Open the battery compartment, then lift up on the battery door to open the back of the receiver. This will expose the tuning coil or coils to be adjusted.

- 
- Step 5:** Locate the Tuning Coil. (See figure on previous page). Each tuning coil is a small, square, shiny metal can with a screwdriver slot in a tuning slug in the top center. The Tuning Slug is usually black or gray.
- Step 6:** With the earphone or headphone supplied with the receiver plugged into the Ear Jack, turn the volume control to a comfortable level, and listen for the transmitted signal.
- Step 7:** Gently put the tip of the tuning wrench into the slot in the tuning slug. Be careful not to push hard on the slug so as not to damage the threads in the coil, and do not screw it down more than 3 turns into the coil.
- Step 8:** Turn the tuning slug in a counter-clockwise direction about two turns. Then, slowly turn the tuning slug in the clockwise direction until the signal is heard. There may be two signal points heard. The one which is received first is a false response. Be sure to continue tuning slightly further to the correct point, which will be much louder. Tune back and forth to find the center of the point of best response to the program being heard.
- Step 9:** Mark down the date, and if a new frequency has been chosen, mark it down inside the receiver case for future reference.

SUGGESTIONS FOR RECEIVER MANAGEMENT

Different types of facilities will use different approaches for receiver management and earphone sanitation. Below are some options that customers have used successfully.

- ▶ Regular users purchase their own receiver and take care of their own batteries and earphone.
- ▶ Some facilities label the receiver and earphone with the names of regular users so each person uses the same receiver and earphone.
- ▶ Ushers issue receivers to people who request them. Earphones are sanitized after use. Foam ear cushions can be replaced or washed with a mild detergent, rinsed thoroughly and air-dried. The EAR 022 Surround Earphone can be sanitized with an alcohol pad.
- ▶ The receivers can be stored in a multiple compartment storage case with a credit card or driver's license left as collateral for the receiver.
- ▶ Regular users purchase their own earphone or headphone and bring them to use with receivers at the facility.



WARRANTY

The Williams Sound T17 Transmitter and R7, R7-4, R7-6, and R16 Receivers are engineered and designed to provide you with many years of reliable service. Williams Sound warrants it against defects in materials and workmanship for FIVE (5) years EXCEPT FOR earphones, headphones, rechargeable batteries, chargers, cables, antennas, carry cases, and all other accessory products. Accessory products carry a 90 day warranty.

If the product fails within the specified warranty period, Williams Sound will determine whether to repair or replace the defective equipment. This warranty does not apply to physical damage, abuse, mis-use, or products that have been modified.

If you experience difficulty with your system, call for Customer Assistance:
1-800-328-6190.

If it is necessary to return the system for service, a Williams Sound representative will give you a Return Authorization Number (RA) and shipping instructions.

Pack the system carefully and send it to:

Williams Sound Corp.
10321 West 70th Street
Eden Prairie, MN 55344-3459 USA

Phone: 800-843-3544
952-943-2252

Fax: 952-943-2174

TTY: 952-943-9675

e-mail: info@williamssound.com

Your warranty becomes effective the date you purchase your system. Your returned warranty card is our way of knowing when your warranty begins. It also gives us important information about your system including the serial number. This information will help us serve you better in the future. Please take a moment to complete and mail the attached card. Thank you.

PERSONAL PA® VALUE PACK SYSTEM SPECIFICATIONS

PERSONAL PA TRANSMITTER MODEL T17

Dimensions & Weight:	3.25" W x 6.875" L x 1.75" H (82.5 mm x 174.6 mm x 44.5 mm) 13 oz., 368.5 g	FCC ID:	CNMT17
Color:	Black	Pre-Emphasis:	75 µS
Power (U.S./Canada):	105-130 VAC, 50-60 Hz, .5 W	Frequency Response:	100 Hz – 15 kHz ±3 dB
Operating Frequencies:	CH A (72.1 MHz), CH B (72.3 MHz), CH C (72.5 MHz), CH D (72.7 MHz), CH E (72.9 MHz), CH F (75.5 MHz), CH G (75.7MHz), CH H (75.9MHz), CH I (74.7 MHz), CH J (75.3 MHz), CH E (72.9 MHz) is standard	Distortion:	1% Max. THD
Frequency Selector:	Internal switches, 10 channels	Signal to Noise Ratio:	55–60 dB with R7 Receiver
RF Field Strength:	8000 µV/m at 30 m Max., 20 mW typical	Microphone Input:	3.5mm mini phone jack, supplies +DC for electret mics
Nominal Range:	300–500 feet, 90–150 m	Mic Input Level:	1–10 mV, nominal
Modulation:	75 kHz (wide-band) max.	Line-Level Input:	RCA Jack, Hi Z, unbal.
Stability:	± .005% over 0-50°C	Line Input Level:	.1–1 Vrms, nominal
		Input Attenuator:	Pot, screwdriver-adjustable
		Antenna Outputs:	Thread Mount for "rubber duckie" flexible whip antenna, optional 75 Ω Coaxial Antenna (ANT 005) uses RG-59 cable, 400 ft. (140 m) max. cable length

*NOTE: FCC Rules limit the use of the 72–76 MHz band to auditory assistance for the handicapped.
Specific transmitter model names contain a frequency code. For example, Model T17E is preset to channel E, 72.9 MHz.*

PERSONAL PA RECEIVERS: MODEL R7*, MODEL R7-4

Model R7:	Single channel, Pre-Tuned, Adjustable (72.9 MHz standard) 10 Channels Available (72.1-75.9 MHz)	Operating Frequencies:	Pre-Tuned, Adjustable, 72 MHz–76 MHz
Model R7-4:	4-Channel, Pre-Tuned, Selectable CH A (72.1 MHz), CH C (72.5 MHz), CH E (72.9 MHz), CH G (75.7 MHz) (OR) CH B (72.3 MHz), CH D (72.7 MHz), CH F (75.5 MHz), CH H (75.9 MHz)	Intermediate Freq.:	75 kHz
Dimensions & Weight:	3-5/8" L x 2-3/8" W x 7/8" H (92.1 mm x 60.3 mm x 22.2 mm) 3.2 oz (90 g) with battery	FM Deviation:	75 kHz
Color:	Gray	De-Emphasis:	75 µS
Battery Type:	9 Volt, Eveready 216 Carbon, Eveready 522 Alkaline, or BAT 003 NiMH Rechargeable	AFC Range:	± 300 kHz
Battery Drain:	14 mA, nominal	Sensitivity:	2 µV at 12 dB Sinad with squelch defeated
Battery Life:	32 hours with Eveready 522, 6 hours/charge with BAT 003	Squelch:	Squelches at 10 µV for minimum 50 dB S/N ratio
FCC ID:	CNM R7Y, CNM R74Y	Input Overload:	20 mV
		Frequency Response:	100–10 kHz, ± 3 dB
		Signal-to-Noise Ratio:	50 dB at 10 µV
		Receive Antenna:	Integral with earphone/headphone cord
		Audio Output:	250 mW, max. at 16 Ohms
		Output Connector:	3.5 mm mini phone jack, also serves as a charging jack for rechargeable battery
		Earphone:	Earbud-type with foam cushion, 3.5 mm plug, 32 Ω (Other styles available)
		R7-4 Channel Selector:	4-position, rotary switch

**NOTE: Specific receiver model numbers contain a frequency code. For example, Model R7E is preset to channel E (72.9 MHz).*



Williams Sound Corp.

10321 West 70th St., Eden Prairie, MN 55344-3459
U.S.A. 800-328-6190 / 952-943-2252 / FAX: 952-943-2174

www.williamssound.com

© 2003, Williams Sound Corp.

MAN 035F